

## GaAs pHEMT MMIC 1 WATT POWER AMPLIFIER, 27.5 - 33.5 GHz

### Typical Applications

The HMC1024 is ideal for:

- Point-to-Point Radios
- Point-to-Multi-Point Radios
- VSAT & SATCOM
- Military & Space

### Features

- Saturated Output Power: +31 dBm @ 29% PAE
- High Output IP3: +40 dBm
- High Gain: 24 dB
- DC Supply: +5V @ 600 mA
- No External Matching Required
- Die Size: 2.79 x 1.3 x 0.1 mm

### Functional Diagram

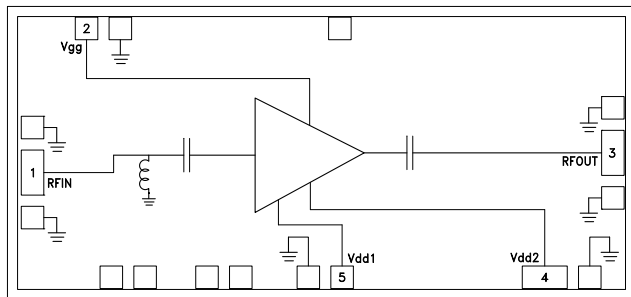

### General Description

The HMC1024 is a four stage GaAs pHEMT MMIC 1 Watt Power Amplifier which operates between 27.5 and 33.5 GHz. The HMC1024 provides 24 dB of gain, +31 dBm of saturated output power, and 29% PAE from a +5 V power supply. The HMC1024 exhibits excellent linearity and is optimized for high capacity point to point and point to multi-point radio systems. The amplifier configuration and high gain make it an excellent candidate for last stage signal amplification before the antenna. All data is taken with the chip in a 50 Ohm test fixture connected via (2) 0.025 mm (1 mil) diameter wire bonds of 0.31 mm (12 mil) length.

### Electrical Specifications, $T_A = +25^\circ C$ , $V_{dd1}, V_{dd2} = +5V$ , $I_{dd} = 600 mA$ [1]

Parameter	Min.	Typ.	Max.			Units
Frequency Range	27.5 - 30			30 - 33.5		GHz
Gain	20.5	23.5		21.5	24.5	dB
Gain Variation Over Temperature		0.025			0.025	dB/ °C
Input Return Loss		12			17	dB
Output Return Loss		12			18	dB
Output Power for 1 dB Compression (P1dB)	27	29		27	28.5	dBm
Saturated Output Power (Psat)		31			30.5	dBm
Output Third Order Intercept (IP3) <sup>[2]</sup>		40			40	dBm
Total Supply Current (Idd)		600			600	mA

[1] Adjust Vgg between -2 to 0V to achieve Idd = 600 mA typical.

[2] Measurement taken at +5 V @ 600mA, Pout / Tone = +20 dBm

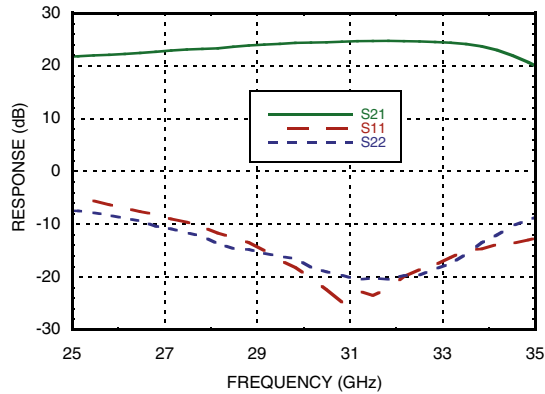
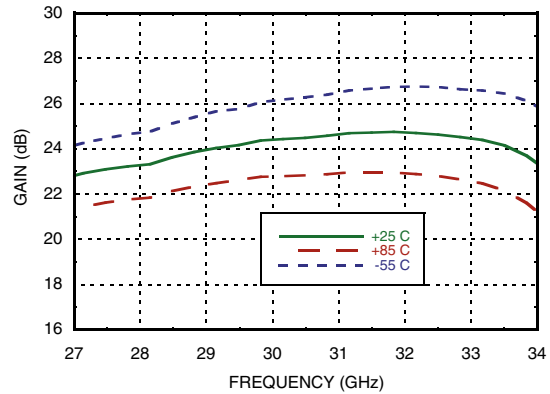
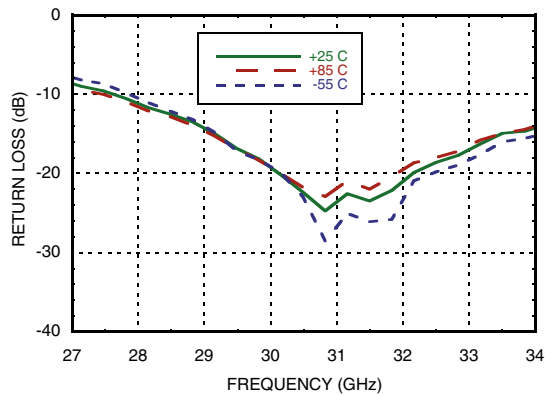
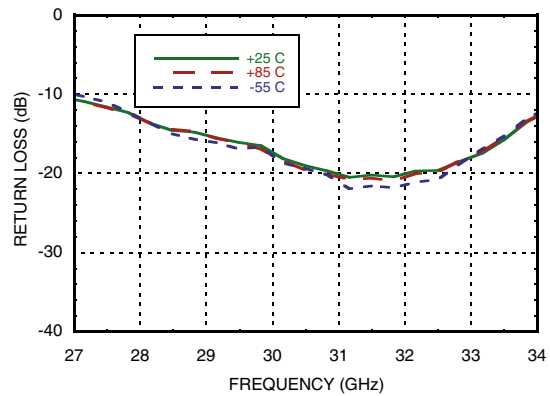
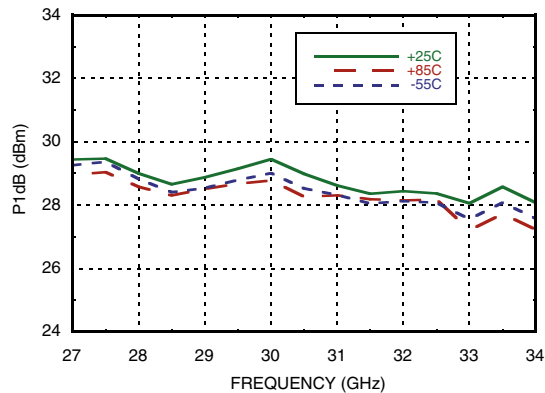
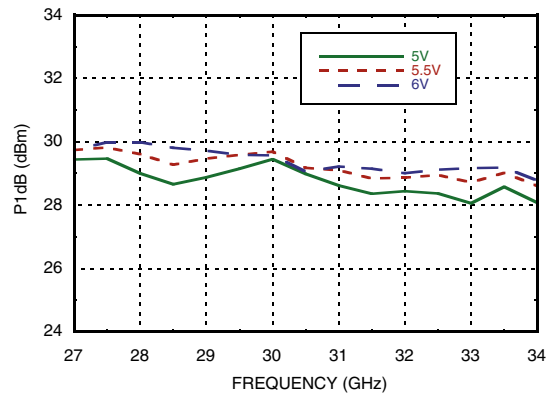
**GaAs pHEMT MMIC 1 WATT  
POWER AMPLIFIER, 27.5 - 33.5 GHz**
**Broadband Gain &  
Return Loss vs. Frequency**

**Gain vs. Temperature**

**Input Return Loss vs. Temperature**

**Output Return Loss vs. Temperature**

**P1dB vs. Temperature**

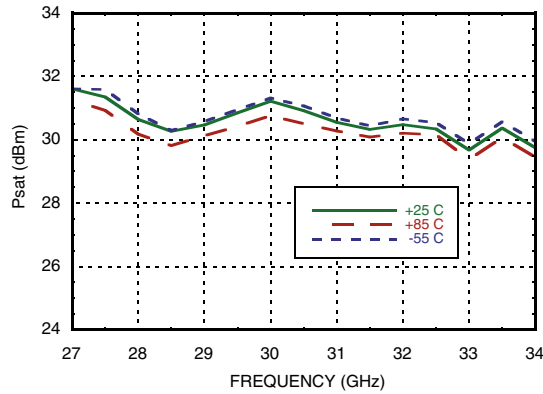
**P1dB vs. Supply Voltage**



**GaAs pHEMT MMIC 1 WATT  
POWER AMPLIFIER, 27.5 - 33.5 GHz**

AMPLIFIERS - LINEAR & POWER - CHIP

**Psat vs. Temperature**



**Psat vs. Supply Voltage**

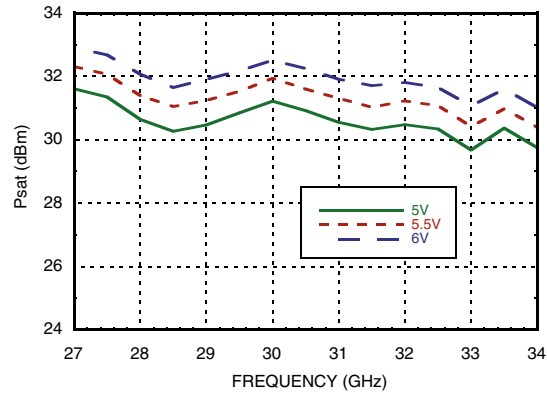

**P1dB vs. Supply Current (Idd)**

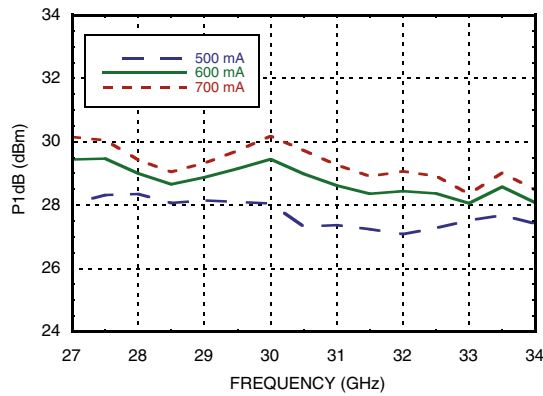

**Psat vs. Supply Current (Idd)**

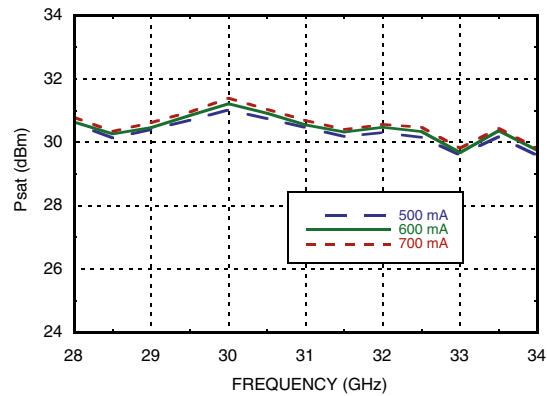

**Output IP3 vs. Temperature, Pout/Tone = +20 dBm**

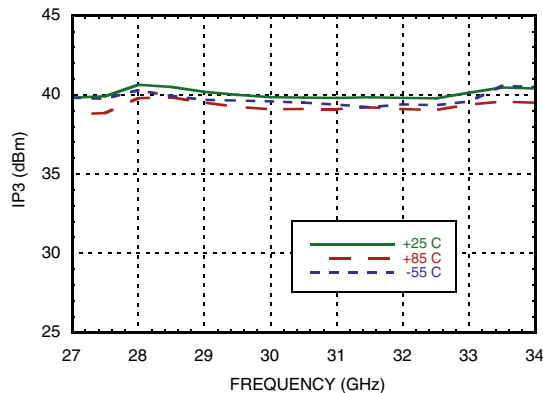

**Output IP3 vs. Supply Current, Pout/Tone = +20 dBm**

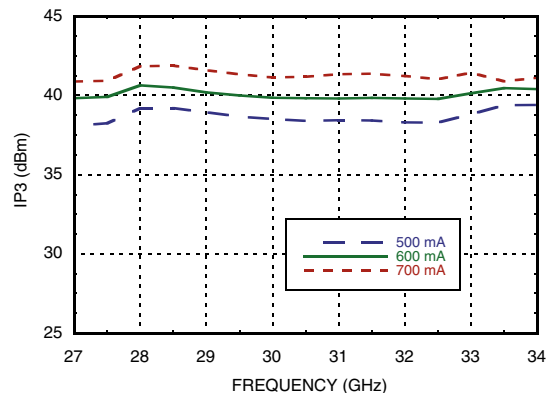

## GaAs pHEMT MMIC 1 WATT POWER AMPLIFIER, 27.5 - 33.5 GHz

**Output IP3 vs.  
Supply Voltage, Pout/Tone = +20 dBm**

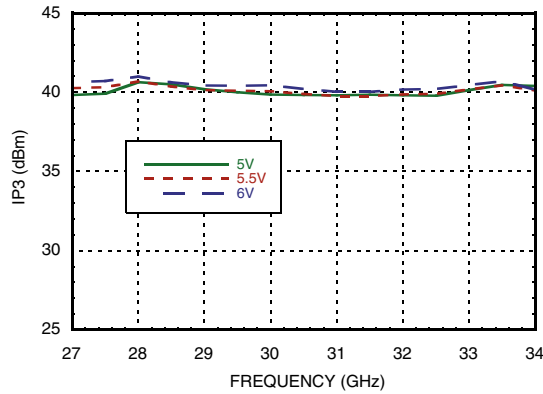

**Output IM3 @ Vdd = +5V**

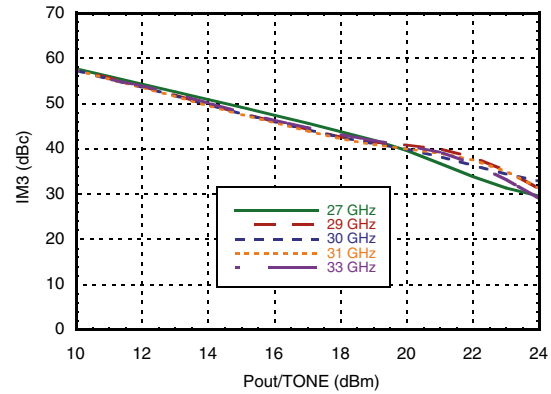

**Output IM3 @ Vdd = +5.5V**

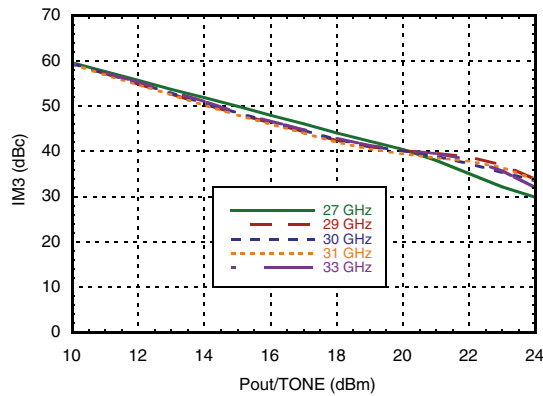

**Output IM3 @ Vdd = +6V**

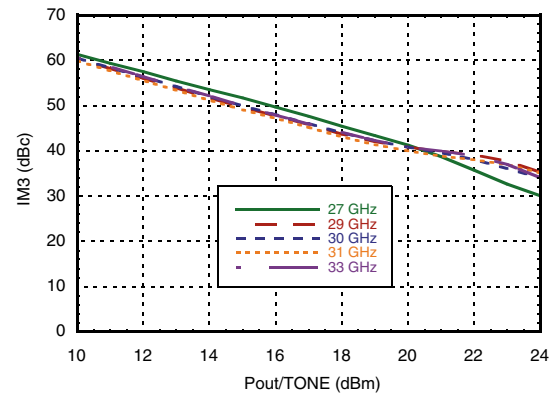

**Power Compression @ 30 GHz**

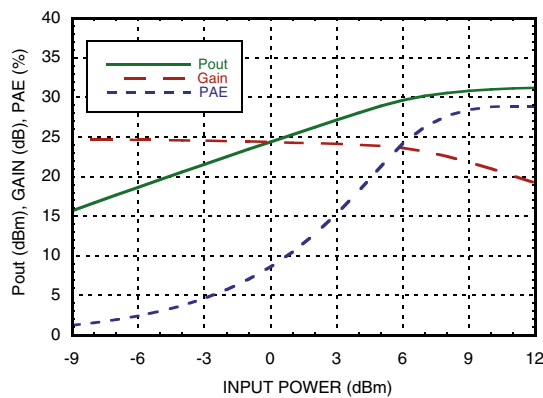

**Gain & Power vs.  
Supply Current @ 30 GHz**

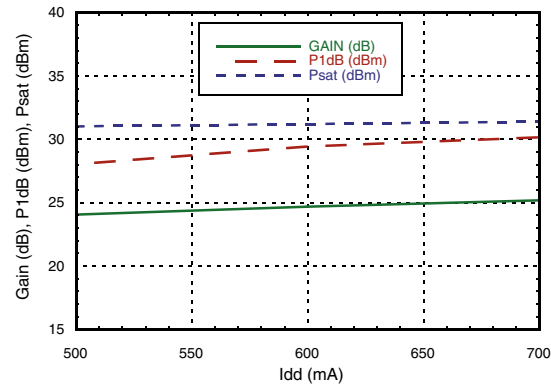



## GaAs pHEMT MMIC 1 WATT POWER AMPLIFIER, 27.5 - 33.5 GHz

### Gain & Power vs. Supply Voltage @ 30 GHz

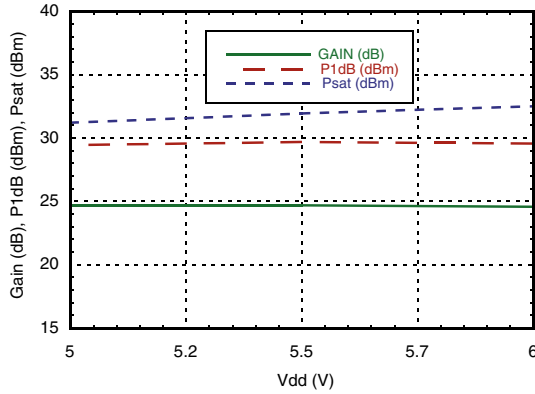

### Reverse Isolation vs. Temperature

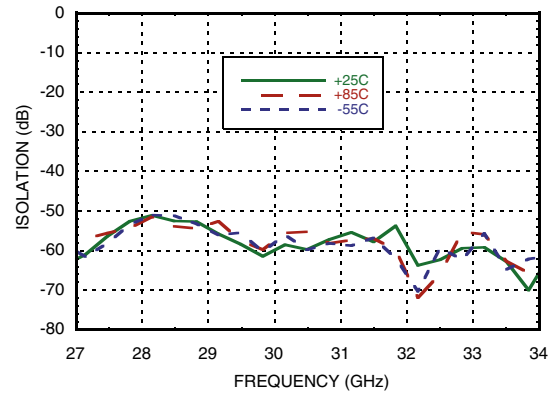

### Power Dissipation

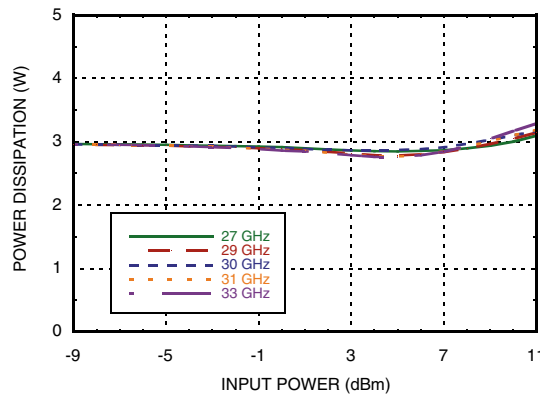

### Absolute Maximum Ratings

Drain Bias Voltage (Vdd)	+7V
RF Input Power (RFIN)	+18 dBm
Channel Temperature	150 °C
Continuous Pdiss (T= 85 °C) (derate 66.6 mW/°C above 85 °C)	4.34 W
Thermal Resistance (channel to die bottom)	15.0 °C/W
Storage Temperature	-65 to +150 °C
Operating Temperature	-55 to +85 °C

### Typical Supply Current vs. Vdd

Vdd (V)	Idd (mA)
+5.0	600
+5.5	600
+6.0	600

Note: Amplifier will operate over full voltage ranges shown above, Vgg adjusted to achieve Idd = 600 mA at +5.5V



**ELECTROSTATIC SENSITIVE DEVICE  
OBSERVE HANDLING PRECAUTIONS**



**GaAs pHEMT MMIC 1 WATT  
POWER AMPLIFIER, 27.5 - 33.5 GHz**

**Outline Drawing**

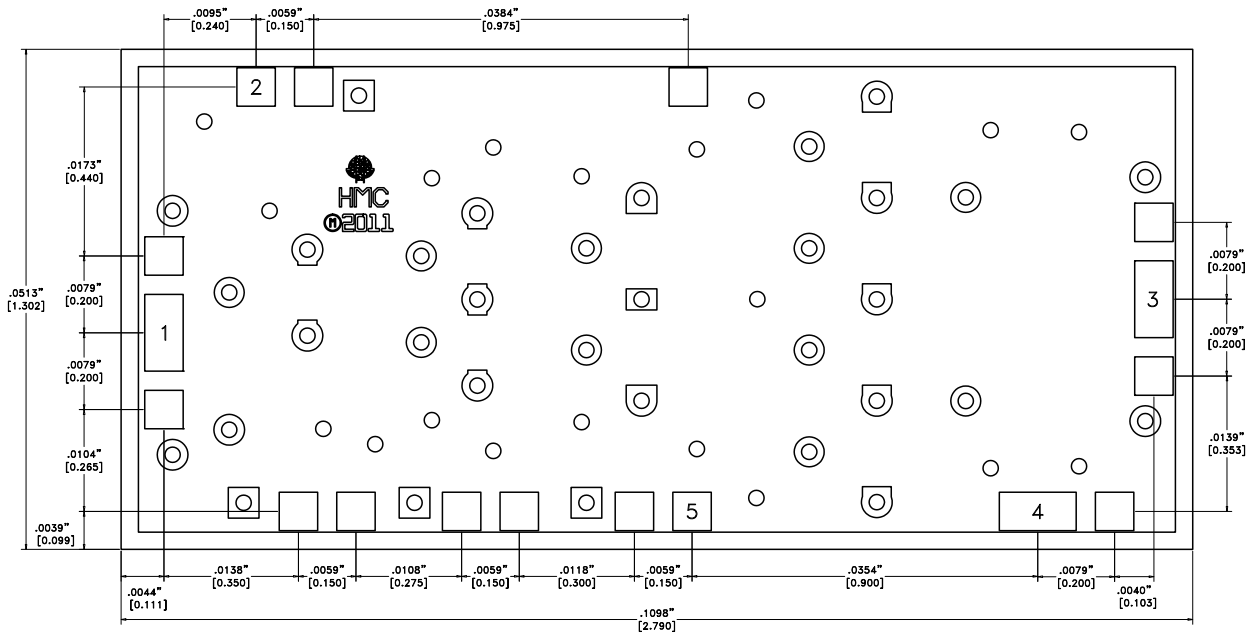

- NOTES:
1. ALL DIMENSIONS ARE IN INCHES [MM]
  2. DIE THICKNESS IS .004"
  3. TYPICAL BOND PAD IS .004" SQUARE
  4. BACKSIDE METALLIZATION: GOLD
  5. BOND PAD METALLIZATION: GOLD
  6. BACKSIDE METAL IS GROUND.
  7. CONNECTION NOT REQUIRED FOR UNLABELED BOND PADS.
  8. OVERALL DIE SIZE ± .002

**Die Packaging Information [1]**

Standard	Alternate
GP-1 (Gel Pack)	[2]

[1] Refer to the "Packaging Information" section for die packaging dimensions.

[2] For alternate packaging information contact Hittite Microwave Corporation.



## GaAs pHEMT MMIC 1 WATT POWER AMPLIFIER, 27.5 - 33.5 GHz

### Pad Descriptions

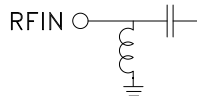
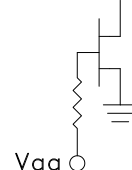
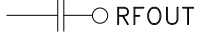
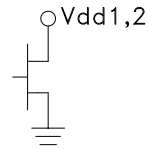
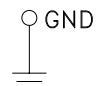
Pad Number	Function	Description	Interface Schematic
1	RFIN	This pad is DC coupled and matched to 50 Ohms.	
2,	Vgg	Gate control for amplifier. Adjust Vgg to achieve recommended bias current. External bypass capacitors 100 pF, 10 nF, and 4.7 uF are required.	
3	RFOUT	This pad is AC coupled and matched to 50 Ohms.	
4, 5	Vdd2, Vdd1	Drain bias voltage. External bypass capacitors of 100 pF are required for each pad., followed by common 10 nF and 4.7 uF capacitors.	
Die Bottom	GND	Die bottom must be connected to RF/DC ground.	

### Application Circuit

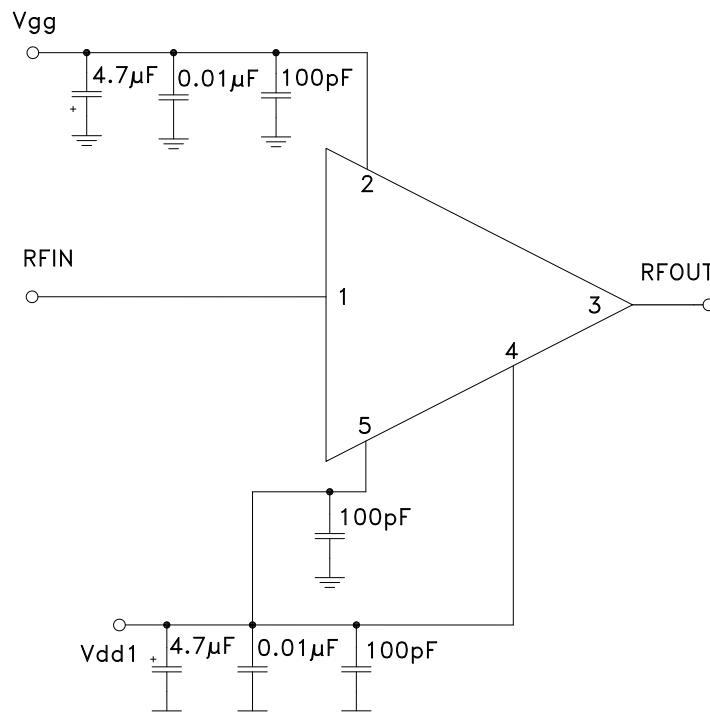

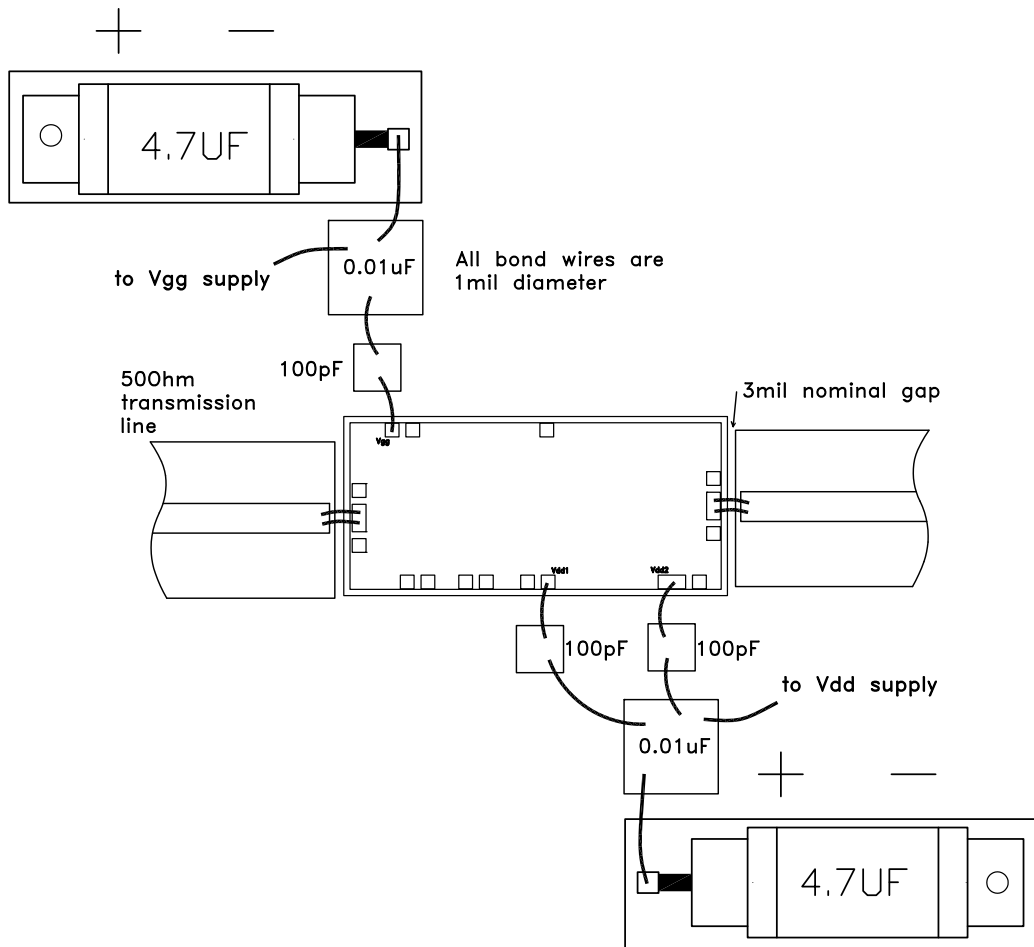
**GaAs pHEMT MMIC 1 WATT  
POWER AMPLIFIER, 27.5 - 33.5 GHz****Assembly Diagram**





## GaAs pHEMT MMIC 1 WATT POWER AMPLIFIER, 27.5 - 33.5 GHz

### Mounting & Bonding Techniques for Millimeterwave GaAs MMICs

The die should be attached directly to the ground plane eutectically or with conductive epoxy (see HMC general Handling, Mounting, Bonding Note).

50 Ohm Microstrip transmission lines on 0.127mm (5 mil) thick alumina thin film substrates are recommended for bringing RF to and from the chip (Figure 1). If 0.254mm (10 mil) thick alumina thin film substrates must be used, the die should be raised 0.150mm (6 mils) so that the surface of the die is coplanar with the surface of the substrate. One way to accomplish this is to attach the 0.102mm (4 mil) thick die to a 0.150mm (6 mil) thick molybdenum heat spreader (moly-tab) which is then attached to the ground plane (Figure 2).

Microstrip substrates should be located as close to the die as possible in order to minimize bond wire length. Typical die-to-substrate spacing is 0.076mm to 0.152 mm (3 to 6 mils).

#### Handling Precautions

Follow these precautions to avoid permanent damage.

**Storage:** All bare die are placed in either Waffle or Gel based ESD protective containers, and then sealed in an ESD protective bag for shipment. Once the sealed ESD protective bag has been opened, all die should be stored in a dry nitrogen environment.

**Cleanliness:** Handle the chips in a clean environment. DO NOT attempt to clean the chip using liquid cleaning systems.

**Static Sensitivity:** Follow ESD precautions to protect against  $> \pm 250V$  ESD strikes.

**Transients:** Suppress instrument and bias supply transients while bias is applied. Use shielded signal and bias cables to minimize inductive pick-up.

**General Handling:** Handle the chip along the edges with a vacuum collet or with a sharp pair of bent tweezers. The surface of the chip may have fragile air bridges and should not be touched with vacuum collet, tweezers, or fingers.

#### Mounting

The chip is back-metallized and can be die mounted with AuSn eutectic preforms or with electrically conductive epoxy. The mounting surface should be clean and flat.

**Eutectic Die Attach:** A 80/20 gold tin preform is recommended with a work surface temperature of 255 °C and a tool temperature of 265 °C. When hot 90/10 nitrogen/hydrogen gas is applied, tool tip temperature should be 290 °C. DO NOT expose the chip to a temperature greater than 320 °C for more than 20 seconds. No more than 3 seconds of scrubbing should be required for attachment.

**Epoxy Die Attach:** Apply a minimum amount of epoxy to the mounting surface so that a thin epoxy fillet is observed around the perimeter of the chip once it is placed into position. Cure epoxy per the manufacturer's schedule.

#### Wire Bonding

Ball or wedge bond with 0.025mm (1 mil) diameter pure gold wire. Thermosonic wirebonding with a nominal stage temperature of 150 °C and a ball bonding force of 40 to 50 grams or wedge bonding force of 18 to 22 grams is recommended. Use the minimum level of ultrasonic energy to achieve reliable wirebonds. Wirebonds should be started on the chip and terminated on the package or substrate. All bonds should be as short as possible  $< 0.31\text{mm}$  (12 mils).

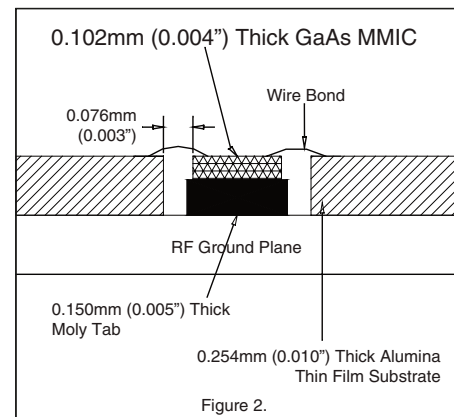
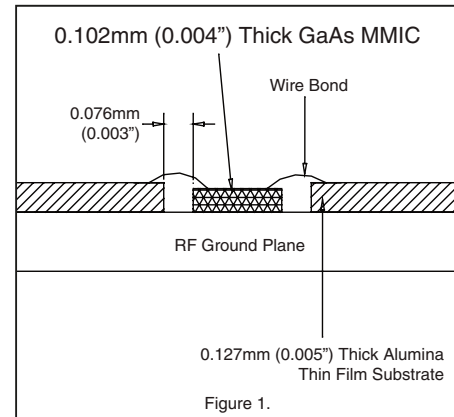



**GaAs pHEMT MMIC 1 WATT  
POWER AMPLIFIER, 27.5 - 33.5 GHz**

**Notes:**